



R32 Air to Water Heat Pump(Outdoor Unit)

Instruction Manual





1. The appliance shall be installed in accordance with national wiring regulations.
2. This appliance is intended to be used by expert or trained users in shops, in light industry and on farms, or for commercial use by lay persons.
3. This appliance is not intended for use by persons (including children) with reduced physical, sensory or mental capabilities, or lack of experience and knowledge, unless they have been given supervision or instruction concerning use of the appliance by a person responsible for their safety.
4. Children should be supervised to ensure that they do not play with the appliance.
5. This appliance can be used by children aged from 8 years or above and persons with reduced physical, sensory or mental capabilities or lack of experience and knowledge if they have been given supervision or instruction concerning use of the appliance in a safe way and understand the hazards involved.
6. Cleaning and user maintenance shall not be made by children without supervision.
7. Disconnect the power source before service or replacing parts.
8. Warning: before obtaining access to terminals, all supply circuits must be disconnected.



- 9. Disconnect the power supply before cleaning and maintenance.
- 10. If the supply cord is damaged, it must be replaced by the manufacturer, its service agent or a similarly qualified person in order to avoid a hazard.
- 11. An all-pole disconnection switch having a contact separation of at least 3mm in all poles should be connected in fixed wiring.
- 12. The appliance shall not be installed in the laundry.
- 13. F-gas , The equipment contains fluorinated greenhouse gas R32,Global Warming Potential(GWP):677

Correct Disposal of this product	
	This marking indicates that this product should not be disposed with other household wastes throughout the EU. To prevent possible harm to the environment or human health from uncontrolled waste disposal, recycle it responsibly to promote the sustainable reuse of material resources. To return your used device, please use the return and collection systems or contact the retailer where the product was purchased. They can take this product for environmental safe recycling.

	outdoor temperature	indoor temperature
cooling mode operation	-5~46°C	-25~40°C
heating mode operation	-28~43°C	-25~40°C
DHW mode operation	-28~43°C	-25~40°C

Table of Contents

1 Safety Precautions	1
2 Construction Check Points	1
3 Installation of Outdoor Unit.....	2
4 Installation of Connecting Pipe	5
5 Electrical Wiring.....	9
6 Test Run	13
Appendix (Names and Content of Hazardous Substances in Products)	

1 Safety Precautions

Warning

* **This air conditioner is a comfortable air conditioner. Please do not use it in special places storing items like computers, precision instruments, food, plants, animals or artware.**

- ⌘ Please entrust a dealer or professional to install. The installer must have relevant professional knowledge. Do not install by yourself, the improper installation will cause fire, electric shock, injury, water leakage and other accidents.
- ⌘ When installing in a small room, take appropriate measures to ensure that the concentration of refrigerant leakage in the room does not exceed a critical level. Please consult your dealer for specific measures.
- ⌘ Observe the regulations of local electric companies when connecting power cables. According to the law, the ground wire must be well connected. If the ground wire is not properly connected, it may cause electric shock.
- ⌘ When the air conditioner needs to be moved or reinstalled, please entrust the dealer or professional to operate. Improper installation will result in fire, electric shock, injury, water leakage and other accidents.
- ⌘ Never modify or repair it yourself. Improper repairing may result in fire, electric shock, injury, water leakage, etc., and must be repaired by a dealer or professional.

Attention

- Confirm that the drainage ditch can drain smoothly.
- Check if the leakage protection switch is installed. The earth leakage protection switch must be installed. If it is not installed, it may cause electric shock.
- Do not install in a place where flammable gases are easily leaked. In the event of a flammable gas leak, it may cause a fire if it is trapped around the indoor unit.
- Confirm that the installation base and hoisting are firm and reliable. If the foundation and hoisting are not strong enough, it may fall and cause an accident.
- Connect the cables correctly. If the cables are not correctly connected, electrical parts may be damaged.
- Exposing the unit to water or other moisture before installation may cause short-circuiting of electrical components. Do not store it in a wet basement or expose it to rain or water.
- If the refrigerant leaks during installation, immediately ventilate the room. If the refrigerant gas leaks out and comes into contact with the fire, it may produce toxic gases.
- After the installation is completed, check and confirm that the refrigerant is not leaked.
- If the refrigerant gas enters the room and comes into contact with a fire source such as a heater, stove or rice cooker, it may produce toxic gases.
- Please install the lightning protection device according to the national laws and regulations, otherwise the machine may be damaged by lightning.

2 Construction Check Points

2.1 Arrival of Goods(AOG) and Out of Box Audit(OOBA)

- 1) After receiving the machine, check for transport damage. If damage is found on the surface or inside, it should be reported to the transportation company immediately in written form.
- 2) After receiving the machine, check whether the model, specification and quantity of the equipment are in accordance with the contract.
- 3) When unpacking, please keep the operating instructions and check the accessories.

2.2 Refrigerant piping

- 1) The refrigerant piping shall use pipeline with specified diameter and wall thickness.
- 2) When the copper tube is welded, it must be filled with nitrogen. Before welding, it is filled with 0.2 kgf/cm² of nitrogen. After the welding is completed, wait until the copper tube is completely cooled and stop the nitrogen supply.
- 3) The refrigerant piping must be insulated.
- 4) After the refrigerant piping is installed, the indoor unit cannot be energized until the airtightness test and vacuuming are performed.

2.3 Air tightness test

After the refrigerant piping is installed, it is necessary to inject nitrogen at a pressure of 40 kgf/cm² (4.0MPa) from the gas side and the liquid side for a 1-hour air tightness test.

2.4 Vacuum treatment

After the air tightness test, vacuum treatment must be carried out simultaneously from both sides of the gas and liquid (vacuum treatment should reach -0.1 MPa).

2.5 Refrigerant adding

- 1) Calculate the amount of refrigerant added based on the pipe diameter and length (solid length) of the liquid side piping between the outdoor unit and the hydronic module.

2.6 Electrical wiring

- 1) Please select the power supply capacity and wire diameter according to the design manual. The power cord of the air conditioner is thicker than the power cord of the general motor.
- 2) To prevent malfunction of the air conditioner, be careful not to make the power cords (220v) to be interleaved and entangled with the communication wire of indoor and outdoor unit (low voltage wiring).
- 3) After performing the airtightness test and vacuum pumping, energize the hydronic module.

2.7 Trial run

Test run can only be performed after at least 3 hours preheating, otherwise the system will be damaged.

3 Installation of Outdoor Unit

Warning

- ⊗ Install the air conditioner in a firm place where the unit can be supported.
- ⊗ If the strength is not enough, the unit may fall and cause personal injury.
- ⊗ Perform specific installation work to prevent strong winds or earthquakes.
- ⊗ Incomplete installation can cause an accident due to the falling of the unit.

3.1 Installation location selection

- 1) Provide sufficient space for installation and maintenance.
- 2) The place shall ensure that the air inlet and outlet are unobstructed and not influenced by the strong wind.
- 3) Dry and ventilated place.
- 4) The supporting surface shall be flat and withstand the weight of the outdoor unit, so that the outdoor unit can be installed horizontally without bringing more noise and vibration.
- 5) Operation noise and exhaust air shall not affect neighbors.
- 6) No flammable gas leaks.
- 7) Easy to install the connecting pipe and electrical connection.

3.2 Dimensions of outdoor unit (unit: mm)

- 1) Model 5kw / 8kw

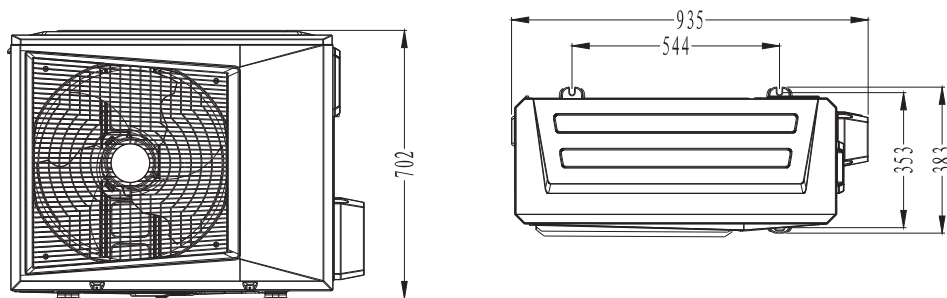

Figure 3-1 Dimensions of outdoor unit

- 2) Model 10kw / 12kw

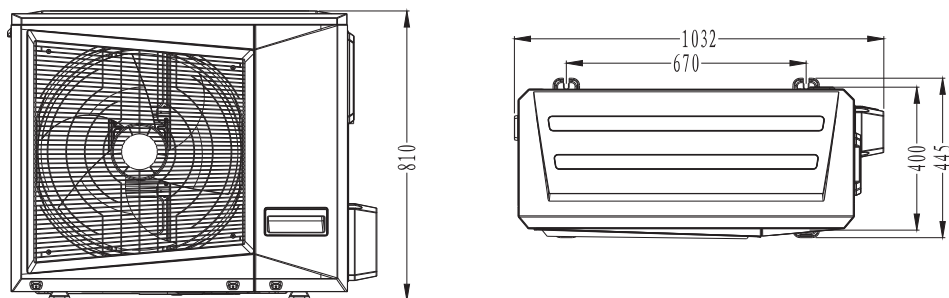

Figure 3-2 Dimensions of outdoor unit

3 Installation of Outdoor Unit

3) Model 14kw / 16kw

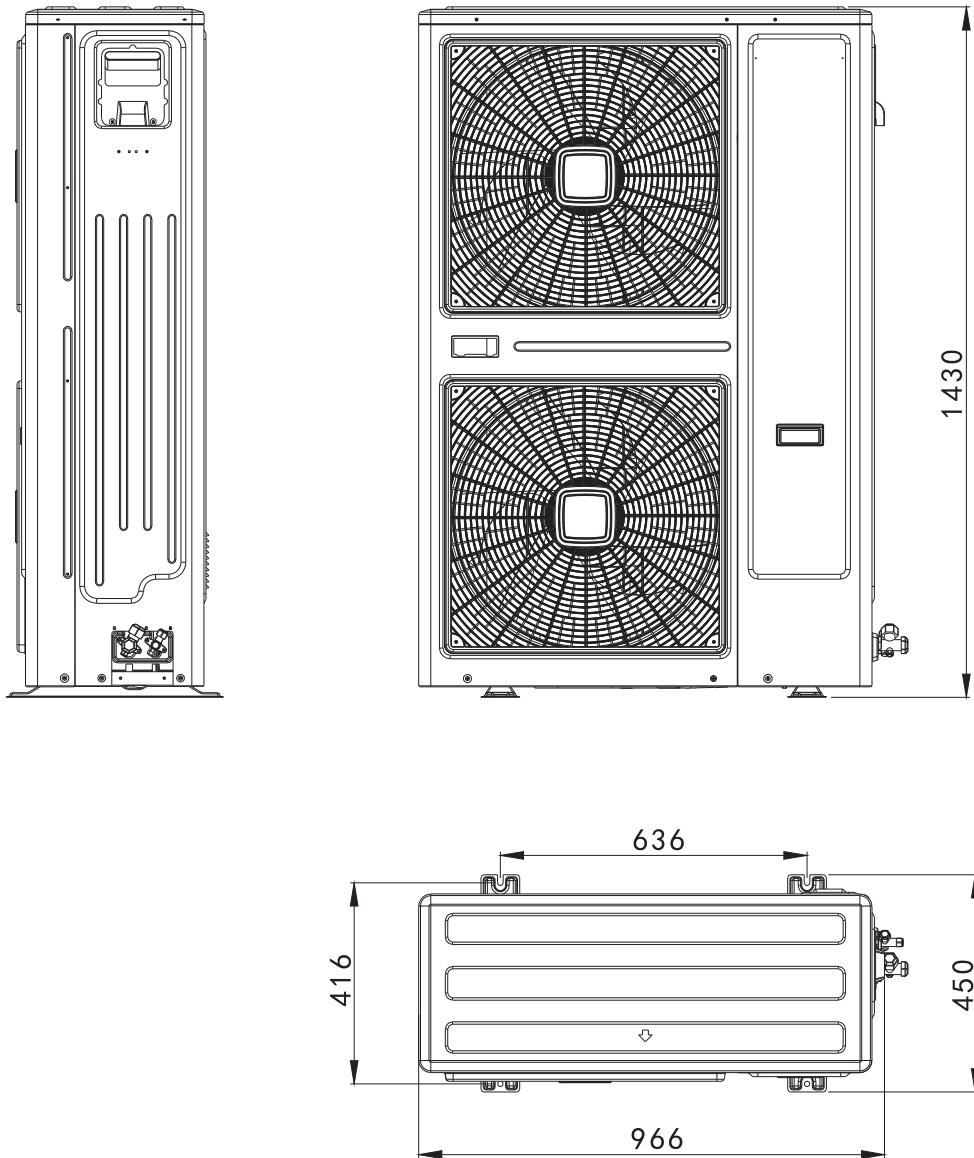

Figure 3-3 Dimensions of outdoor unit

3 Installation of Outdoor Unit

3.3 Hoisting of outdoor unit

1) A solid and proper foundation has the following effects:

- ① The outdoor unit will not sink.
- ② The outdoor unit does not generate abnormal noise caused by the foundation.

2) Types of foundation

- ① Steel structure foundation.
- ② Concrete foundation (refer to the following figure).

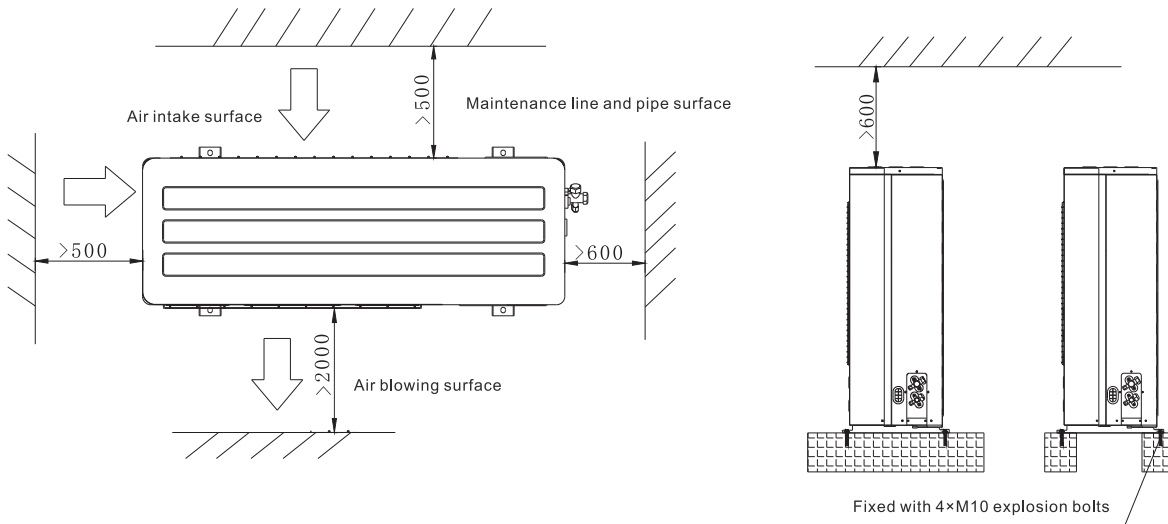

Figure 3-3 Outdoor unit installation and maintenance space Unit:mm

- ⊗ Please entrust a dealer or professional to install. The installer must have relevant professional knowledge. If it is wrongly installed by yourself, it may cause fire, electric shock, injury, water leakage and so on.
- ⊗ When installing in a small room, provide appropriate measures to ensure that the concentration of refrigerant leakage in the room does not exceed a critical level. Please consult your dealer for specific measures.
- ⊗ Observe the regulations of the local electric companies when making power connection. According to the law, the ground wire must be well connected. If the ground wire is not properly connected, it may cause electric shock.
- ⊗ When the air conditioner needs to be moved or reinstalled, please entrust the dealer or professional to operate. Improper installation will result in fire, electric shock, injury, water leakage and other accidents.
- ⊗ Never modify or repair it by yourself. Improper repairing may result in fire, electric shock, injury, water leakage, etc., and must be repaired by a dealer or professional.

4 Installation of Connecting Pipe

4.1 Refrigerant piping

1) Flaring

Cut the pipe with the pipe cutter, and flare with a pipe expander.

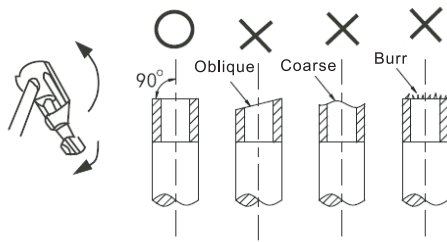
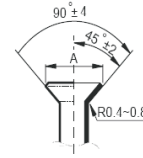

Figure 4-1 Cutting of the connecting tube

Table 4-1 Flaring size of connection tube

Outer diameter (mm)	A(mm)	
	MAX	MIN
Φ9.5	12.4	12.0
Φ15.9	19.0	18.6



2) Fastening nut

Align the connecting tube, tighten the nut by hand, and then tighten with a wrench.

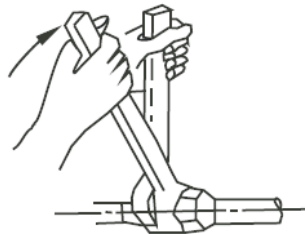

Figure 4-2 Tightening

Table 4-2 Tightening torque

Piping size (mm)	Tightening torque (N·m)
Φ9.5	32.7~39.9(333~407 kgf·cm)
Φ15.9	61.8~75.4(630~770 kgf·cm)

Attention

- ⌘ In order to prevent oxidation inside the copper tube during copper pipe welding, nitrogen filling must be taken. Otherwise the scale will block the refrigeration system!
- ⌘ When the nut is tightened, too much force will break the bell mouth, and too little force will cause leakage. Please refer to the tightening torque in the above table to tighten the nut!

4.2 Connection diagram of hydronic module and outdoor unit

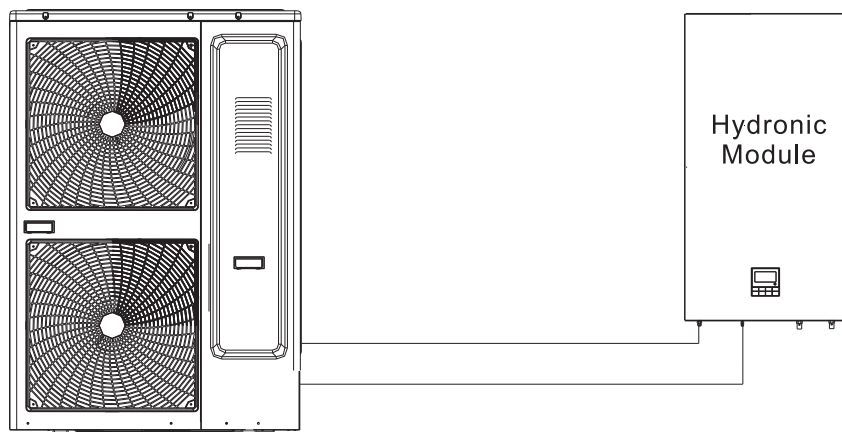

Figure 4-3

4 Installation of Connecting Pipe

4.3 Accessory pipe in the pipeline

Because of different mounting positions of the heat pump, the required accessory pipe can be long or short, to avoid too long refrigerant pipe affecting the unit capacity, please select a reasonable pipe length according to table below, try to select the location of the short pipe for the installation.

1. The maximum allowable operating distance away from the pipe

Rated refrigerating capacity Value	<6.5kW	6.5~10.5kW	≥10.5kW
	A Pipeline length (one-way)	Maximum length 15m	Maximum length 20m
B Height difference(one-way)	Maximum length 8m	Maximum length 10m	Maximum length 20m
C Pipeline bends quantity	Up to 10	Up to 10	Up to 15

Note: On condition that 80% of the capacity is guaranteed, in the above parameters, the cooling capacity loss and return oil has been fully considered.

2. The use of oil return elbow

When the height difference between the indoor and outdoor unit is greater than 5 m, in order to facilitate oil return of the compressor, oil return elbow must be used. Upon site operations, the following typical installation methods can be referred to (see Figure below).

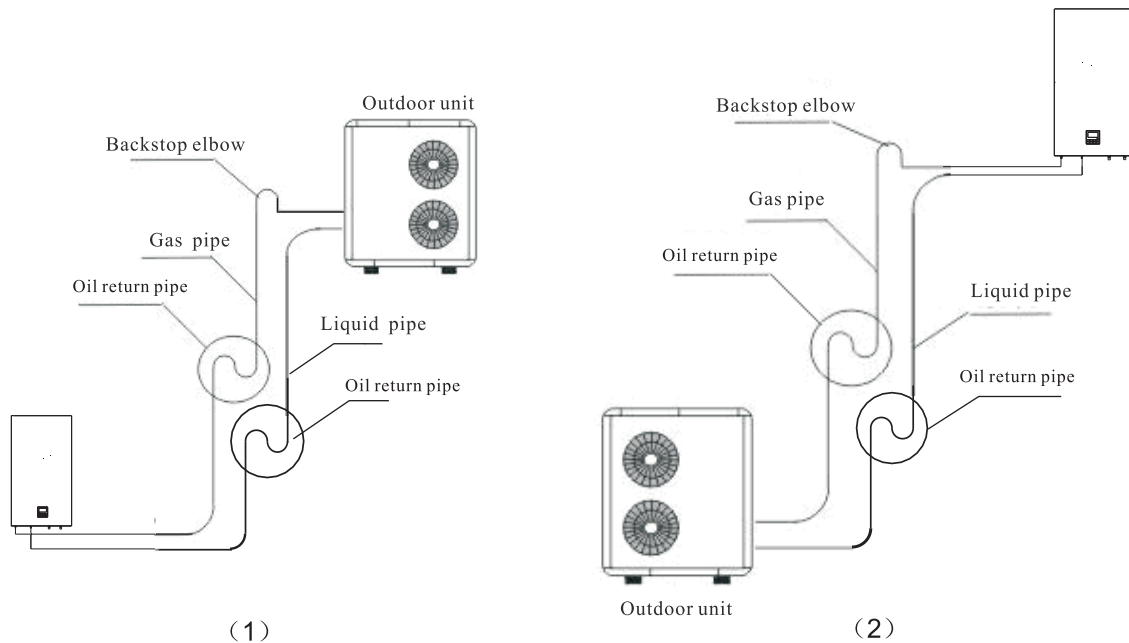

Note: Oil return elbow radius $R \leq 100\text{mm}$, oil return elbows must be located per 5m as shown above; when the height difference between indoor and outdoor unit exceeds five meters, oil reserve elbow and backstop elbow should be set according to the relative position of outdoor unit and indoor unit.

4 Installation of Connecting Pipe

4.4 Determination of the main pipe diameter

Table 4-4 Main Pipe Diameter

Model	Main pipe dimensions			
	Pipeline length (one-way) < 30m		Pipeline length (one-way) ≥ 30m	
	Liquid pipe	Gas pipe	Liquid pipe	Gas pipe
5kw outdoor 8kw outdoor 10kw outdoor 12kw outdoor	Φ9.52	Φ15.88	Φ9.52	Φ15.88
14kw outdoor 16kw outdoor	Φ9.52	Φ15.88	Φ9.52	Φ19.05

4.5 Remove the foreign matter inside the pipe

- 1) Before the refrigerant piping is installed, foreign matter inside the pipe must be removed with high pressure nitrogen.
- 2) The hydronic module shall not be connected during cleaning.
- 3) It is not possible to replace nitrogen with flammable and toxic gases such as refrigerant or oxygen.

4.6 Air tightness test

- 1) After the refrigerant piping is installed and connected to the hydronic module, the nitrogen with pressure of 40kgf/cm² (4.00 MPa) should be injected from the gas side and the liquid side before connecting the pipe between the indoor and the outdoor to the outdoor unit valve. Mark the pressure value and perform 8-hour air tightness test.
- 2) If a pressure drop is found, re-examine the leakage of all interfaces and re-pressurize for 8 hours after completion.
- 3) The outdoor unit cannot be connected when holding pressure.

4.7 Vacuum pumping

- 1) A vacuum pump with a vacuum degree of -0.1μm or less and gas displacement of above 40 L/min shall be used.
- 2) The outdoor unit does not need to be vacuumed. Do not open the shut-off valve on the gas side or liquid side of the outdoor unit.
- 3) Confirm that the vacuum pump can work below - 0.1 MPa after running for more than 1 hour. If it cannot work below - 0.1 MPa after running for more than 2 hours, it indicates that there is moisture or gas leakage inside and needs to be checked.
- 4) The vacuum pump must be equipped with a check valve.

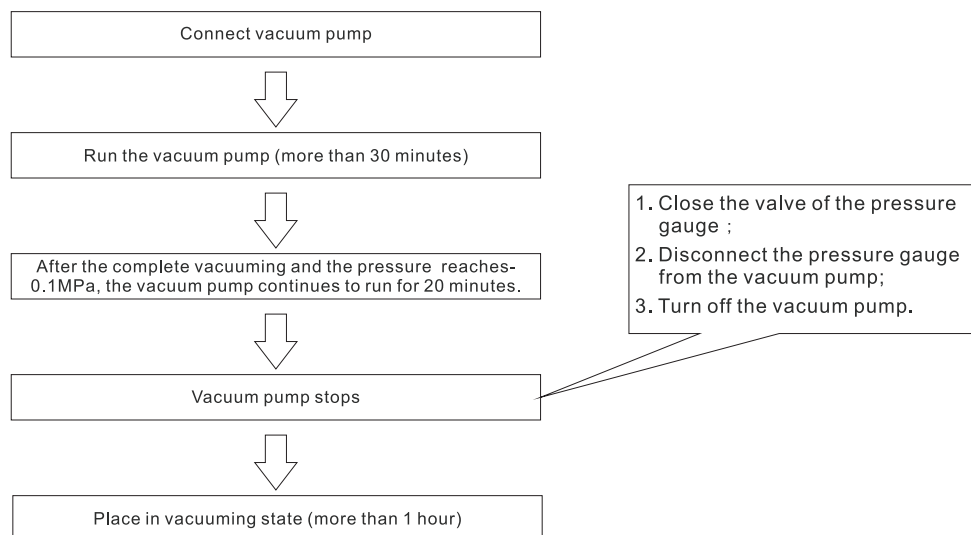

Attention

- ⊗ Do not mix tools and measuring instruments used for different refrigerants and in direct contact with the refrigerant.
- ⊗ Never remove air with refrigerant gas.
- ⊗ When the vacuum degree cannot reach -0.1 MPa, please consider whether there is a possibility of leakage. Please confirm again if there is any leakage. If there is no leak, run the vacuum pump for one or two more hours.

4 Installation of Connecting Pipe

4.8 Adding amount of refrigerant

The calculation method of the adding amount of refrigerant is shown in the following table, based on the pipe diameter and length of connection liquid-side piping between the outdoor unit and the hydronic module.

Table 4-7 Adding amount of refrigerant

Liquid measuring pipe diameter (mm)	Pipe length (m)	Adding amount of refrigerant (Kg)
Φ9.52	≤5	0
Φ9.52	>5	Add 0.03 Kg for each additional 1m

Note: R32 refrigerant must be charged in liquid form with fixed amount measured by electronic scale.

4.9 Instructions for use of the shut-off valve

- 1) It shall be in OFF state when delivery.
- 2) Open or close the valve with a 6 mm hex wrench, counterclockwise turning for opening and clockwise turning for closing.
- 3) The valve cover must be tightened after the operation.
- 4) The operation of vacuuming and refrigerant injection at the service port must be operated with the special tool R32. Inject the refrigerant at the gas side valve service port, and vacuum at the liquid side and the gas side valve service port.

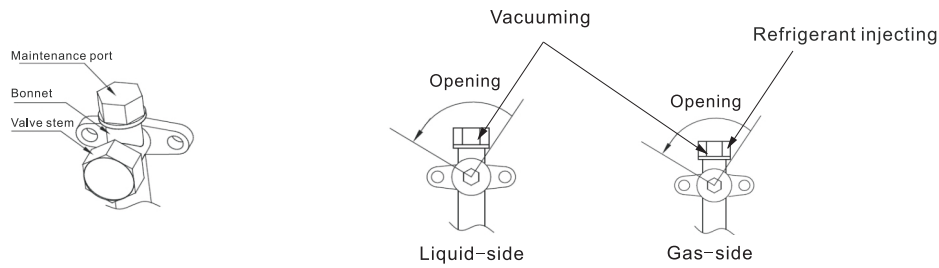

Figure 4-4 Illustration of the shut-off valve

4.10 Pipe insulation treatment

- 1) Insulate the gas side and liquid side pipes separately.
- 2) Use closed-cell insulation material, with B1 flame retardant rating and 120°C high temperature resistance.
- 3) The outer diameter of the copper tube is ϕ 9.52, the thickness of the insulation cotton is not less than 15 mm; the outer diameter of the copper tube is ϕ 15.88, and the thickness of the insulation cotton is not less than 20 mm.
- 4) The nut joint of the hydronic module must also be insulated.

! Attention

- ⌘ Please design the dedicated power supply for the hydronic module and the outdoor unit.
- ⌘ The power supply uses a branch circuit and must be equipped with the leakage protector and manual switch.
- ⌘ Please treat the connecting wires of hydronic module and the refrigerant piping as a same system.
- ⌘ For indoor and outdoor communication wires, please use two-core or three-core shielded twisted pair to reduce interference, instead of using ordinary multi-core cables.
- ⌘ Performed in accordance with the relevant national electrical standards.
- ⌘ The wiring of power supply must be performed by a professional electrician.

5 Electrical wiring

5.1 Hydronic module/Outdoor unit wiring

Table 5-1 Hydronic Module/Outdoor Unit Wiring

Model	Power supply		Power cord (mm ²)	Circuit breaker / fuse (a)	Hydronic module/outdoor unit signal line (mm ²) (weak signal line)
5/8/10/12kW	Single phase	220-240V~50Hz	3×4.0	40/30	3-core shielded cable 3×0.75 (2-core shielded cable 2×0.75)
14/16kW	Three phase	380-415V3N~50Hz	5×4.0	63/45	

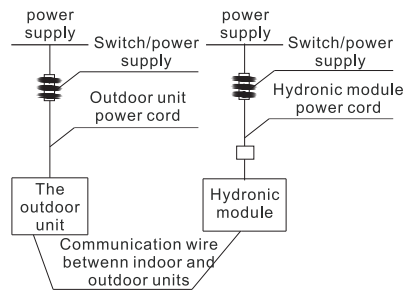

Figure 5-1 Wiring and Control

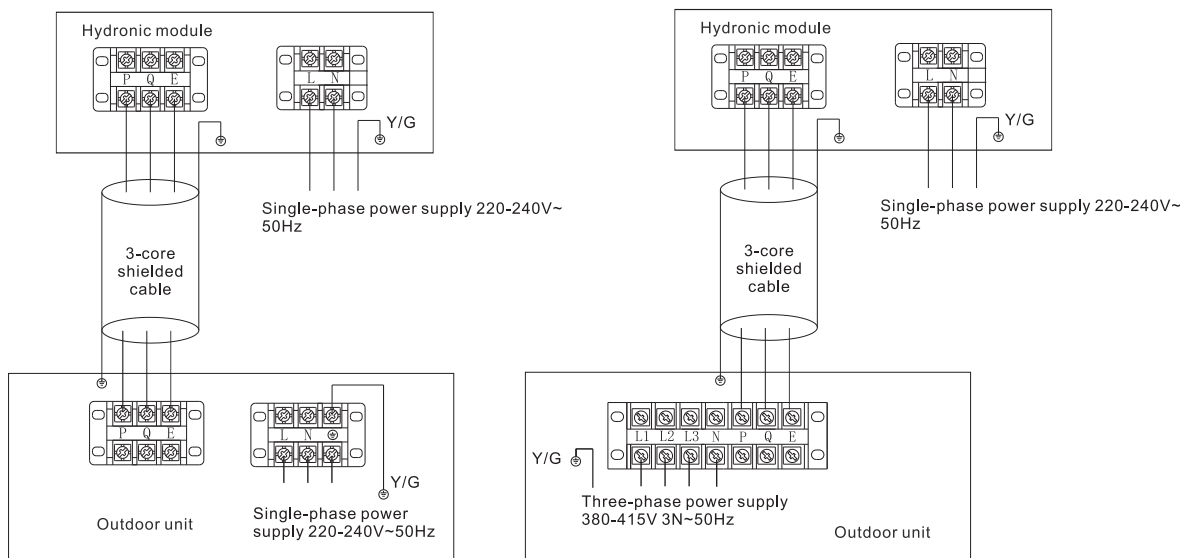

Figure 5-2 Electrical connection mode of single-phase/three-phase outdoor unit

Attention

- ⊗ When using the 2-core shielded wire as the signal wire, connect the shielded mesh to "e" of the terminal block. When using the 3-core shielded wire as the signal wire, the shielded mesh must be grounded.
- ⊗ It is absolutely forbidden to connect the power line (strong power) to the signal wire (weak power) terminal block, otherwise the electric control board will be burned out.

5.2 Power cables for hydronic module





Attention

When the power cord is parallel to the signal wire, place the wires in their respective conduits and leave a suitable line spacing (10A or less: 300 mm, 50A or less: 500 mm).

5 Electrical Wiring

5.3 Main control board dial code setting

Table 5-2 Main Control Board Dial Code

Dialing content	Switch number	Dial code	Set value
Start time setting (14、16kW)	SW3		Start time 12 min
			Start time 3 min
Ability setting	Sw6		CLP-V14HW/DZR4
			CLP-V16HW/DZR4 — —
	0	CLP-V5HW/DR4	
	1	CLP-V8HW/DR4	
	2	CLP-V10HW/DR4	
	3	CLP-V12HW/DR4	
4	Reserved		
...	...		

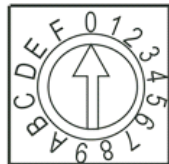

5 Electrical Wiring

5.4 Outdoor unit check instructions

Table 5-3 Outdoor unit spot check table

SN		Display content	Remarks
0	Normal display	Current frequency / number of indoor unit	Display the number of units being started
1	1-	Capacity of outdoor units	50/80/100/120/140/160
2	2-	Total capacity of indoor units	
3	3-	Total capacity required after correction of outdoor unit	
4	4-	Operation mode	0: Standby; 2: Cooling; 3: Heating; 4: Forced cooling
5	5-	Actual operating capacity of outdoor unit	
6	6-	Fan status	0-8
7	7-	Tw-in water inlet temperature of heat exchanger	
8	8-	Tw-out water outlet temperature of heat exchanger	
9	9-	T1 hydronic module outlet temperature	
10	10-	T3 condenser temperature of outdoor unit	
11	11-	T4 ambient temperature	
12	12-	T5 exhaust temperature	
13	13-	Opening of electronic expansion valve	50/80/100/120:Actual value = Check display value × 4;140/160:Actual value = Check display value × 8
14	14-	High pressure	
15	15-	Primary current	
16	16-	Secondary current	
17	17-	Primary voltage	
18	18-	Secondary voltage	
19	19-	Last failure or protection code	No protection or fault display --
20	20-	Control parameter	For developers only
21	21-	Control parameter	For developers only
22	22-	--	End of check

5 Electrical Wiring

Table 5-4 Outdoor unit fault codes

Display content	Failure or protection definition	Remarks
E1	Three-phase supply phase-sequence fault	
E2	Communication failure between indoor unit and outdoor unit	Communication interrupted for 2mins or more between ODU and IDU
E4	Ambient temperature sensor failure	
E6	Condenser temperature sensor failure	
E9	AC over voltage / under voltage protection	
E10	EEPROM failure	
H0	Communication failure between the main control chip and the module board	
H1	Communication failure between the main control chip and the communication chip	
H4	Display P6 protection for 3 times within 30 minutes	It can only be restored by repowering on the unit
H5	Display P2 protection for 3 times within 30 minutes	It can only be restored by repowering on the unit
H6	Display P4 protection for 3 times within 100 minutes	It can only be restored by repowering on the unit
H9	Display P9 protection for 2 times within 10 minutes	It can only be restored by repowering on the unit
H8	High pressure sensor failure	Exhaust pressure $P_c < 0.3\text{MPa}$
H10	Display P3 or P14 protection for 3 times within 60 minutes	It can only be restored by repowering on the unit
P1	High pressure protection (high voltage switch)	
P2	Low voltage protection	3 times P2 protection appears within 30 minutes and then reported H5
P3	Primary current overcurrent protection	
P4	Exhaust temperature is too high protection	3 times P4 protection appears within 100 minutes and then reported H6
P5	T3 high temperature protection	
P6	Module protection	3 times P6 protection appears within 30 minutes and then reported H4
P9	DC fan failure	2 times P9 protection appears within 10 minutes and then reported H9
P10	Typhoon protection	
P12	During heating operation the fan is in fault state in the area A for 5 minutes.	
P14	Secondary current overcurrent protection	
P15	High pressure protection (high pressure sensor)	
L0	DC compressor module failure	
L1	DC bus low voltage protection	
L2	DC bus high voltage protection	
L4	MCE fault / synchronization / closed loop	
L5	Zero speed protection	
L7	Phase sequence error protection	
L8	Protection for speed change $>15\text{Hz}$ at the previous and last moments	
L9	Protection for set speed and actual running speed difference $>15\text{ Hz}$	

6 Test run

6.1 Inspection before commissioning

- 1) Check and confirm that the refrigerant pipes and communication wires for the hydronic module and the outdoor unit are connected to the same refrigeration system. Otherwise, an operational failure will occur.
- 2) The power supply voltage is within $\pm 10\%$ of the rated voltage.
- 3) Check and confirm that the power cable and control cable are connected correctly.
- 4) Before powering up, check and confirm that there is no short circuit in each line.
- 5) Check whether all units have passed the 24-hour nitrogen pressure maintaining test (40 kgf/cm²).
- 6) Check and confirm that the system to be commissioned has been vacuum dried and filled with refrigerant as required.

6.2 Preparation before commissioning

- 1) Calculate the adding amount of refrigerant to be added to each unit according to the length of the liquid pipe on site.
- 2) Prepare the required refrigerant.
- 3) Prepare the system plan, system piping diagram and control circuit diagram.
- 4) Turn on the outdoor unit power switch in advance to ensure that it is turned on for more than 3 hours to heat the compressor oil.
- 6) Check if the power phase sequence of the outdoor unit is correct.
- 7) Check that all the DIP switches of the outdoor unit and hydronic module have been set according to the product technical requirements.

6.3 Hand over to the customer

- 1) Be sure to give the "Installation Manual" of the outdoor unit to the customer.
- 2) Explain the contents of the "Operation and Installation Manual" to the customer in detail.

Appendix 1: Names and contents of hazardous substances in the product

Part Name						
	Lead (Pb)	Mercury (Hg)	Cadmium (Cd)	Hexavalent chromium (Cr (VI))	Polybrominated biphenyl (PBB)	Polybrominated diphenyl ether (PBDE)
Compressor and accessories	×	○	×	○	○	○
Heat exchanger	○	○	○	○	○	○
Pipe fittings and valves	×	○	○	○	○	○
Refrigerant	○	○	○	○	○	○
Motor	×	○	×	○	○	○
Control box and electrical components	×	○	×	○	○	○
Power cords and cables	×	○	○	○	○	○
Fasteners such as screws and gaskets	×	○	○	○	○	○
Rubber parts	○	○	○	○	○	○
Other metal parts	○	○	○	○	○	○
Other plastic parts	○	○	○	○	○	○
Printed parts	○	○	○	○	○	○
Foam pieces	○	○	○	○	○	○
Insulated cotton	○	○	○	○	○	○

The sheet is prepared in accordance with the specification of SJ/T 11364.

○ : It indicates that the content of this hazardous substance in all homogeneous materials of this part is below the limit specified by GB/T 26572.

× : It indicates that the content of the hazardous substance in at least one of the homogeneous materials of the part exceeds the limit specified by GB/T 26572. However, it is temporarily impossible to realize that the product parts are completely free from the above-mentioned hazardous substances under the existing technical conditions. The above-mentioned harmful substances will be gradually reduced with the progress of alternative technologies.

